

BS7200 Operator Software
for digifas™ 7100 / 7200

Previous editions

Edition	Remark
12 / 94	First edition, valid for software version 4L10/4B20 or higher
08 / 95	Valid for software version 5L30/5A20, parameters for digifas™ 7100 integrated
09 / 96	Valid for software version 6L40/6A40
05 / 97	Valid for software version 7L20/7Axx/7Bxx, valid for digifas® 7206
09 / 97	SSD version

IBM AT is a registered trademark of International Business Machines Corp.

PC AT is a registered trademark of International Business Machines Corp.

VGA is a registered trademark of International Business Machines Corp.

MS-DOS is a registered trademark of Microsoft Corp.

WINDOWS is a registered trademark of Microsoft Corp.

digifas is a registered trademark of Seidel Corp. (Regd.TM.No 1549070)

**Technical changes to improve the performance of the software
may be made without prior notice!**

Printed in the Federal Republic of Germany 05/97

Mat. no. 83107

All rights reserved. No part of this work may be reproduced in any form (by printing, photocopying, microfilm or any other method) or stored, processed, copied or distributed by electronic means without the written permission of Seidel Corporation.

Contents	Diagram	Page
Contents		A
Safety instructions		C
Directives and standards		D
I General Information		
I.1 Preface		I-1
I.2 Further documentation		I-1
I.3 Use as directed		I-1
I.4 Abbreviations used		I-2
I.5 Software description		I-2
I.6 Hardware requirements		I-3
I.7 Communications cable: digifas™ ⇔ PC (parallel interface)		I-4
I.8 Communications cable: digifas™ ⇔ PC (serial interface)	- A.4.011.1/9	I-4
II Installation / Operation		
II.1 Installation under DOS		II-1
II.2 Program start		II-1
II.3 Creating a boot disk		II-2
II.4 Other operating systems		II-2
II.5 Screen Layout	- A.4.024.3/3	II-3
II.6 Operation		II-4
II.7 Function keys		II-5
II.8 Status line, screen line 2		II-5
II.9 Error and status messages, screen line 3		II-6
II.10 Actual-value display		II-6
III Description of parameters		
III.1 Menu page "Handling"		III-1
III.1.1 Save to EEPROM		III-1
III.1.2 Edit Offline		III-1
III.1.3 Select directory	- A.4.024.3/6	III-2
III.1.4 Save to disk	- A.4.024.3/5	III-3
III.1.5 Load from disk	- A.4.024.3/4	III-4
III.1.6 Load default settings	- A.4.024.3/11	III-6
III.1.7 Print parameters	- A.4.024.3/7	III-8
III.2 Menu Page "Current controller"		III-9
III.2.1 I _{rms} , effective current		III-9
III.2.2 I _{peak} , peak current		III-9
III.2.3 I ² t message		III-9
III.2.4 K _p , P-gain		III-9
III.2.5 T _n , integration time		III-9

Contents	Diagram	Page
III.3 Menu page "Speed controller"		III-10
III.3.1 Kp, P-gain		III-10
III.3.2 Tn, integration time		III-10
III.3.3 PID-T2, second time constant		III-10
III.3.4 SW offset		III-10
III.3.5 SW ramp +		III-10
III.3.6 SW ramp -		III-11
III.3.7 Speed limit		III-11
III.3.8 DC monitor		III-11
III.3.9 Limit switch / Stop		III-12
III.3.10 Start Phi, phase shift		III-12
III.3.11 Limit Phi, phase shift		III-12
III.3.12 T-Tacho, actual speed value filter		III-12
III.3.13 Speed steadiness		III-12
III.4 Menu page "General"		III-13
III.4.1 Language		III-13
III.4.2 No. of motor poles		III-13
III.4.3 No. of resolver poles		III-13
III.4.4 Position output		III-13
III.4.5 I/O		III-14
III.4.6 Ballast resistor (only for digifas™ 7103...7116)		III-15
III.4.7 Ballast power		III-15
III.4.8 Control of motor holding brake	- A.4.012.3/2	III-15
III.5 Menu page "Service"		III-17
III.5.1 Parameter update (F2)		III-17
III.5.2 Constant direct current (F5, F9)		III-17
III.5.3 Const. speed (F6, F9)		III-17
III.5.4 Const. current (F7, F9)		III-17
III.5.5 Reverse mode (F8, F9)		III-17
III.6 Menu page "Actual values"		III-18
III.7 Menu page "Connect"		III-18
IV Drive optimization		
V Appendix		
V.1 Delivery package, storage, disposal		V-1
V.2 Fault-finding		V-1
V.3 Glossary		V-2
V.4 Operating parameter list		V-4
V.5 Index		V-5

Safety instructions

Warning signs : you must observe the important instructions in the text, which are indicated by the following symbols:



**hazard from electricity
and its effects**



**general warning
general instruction**

- ◆ **Only properly qualified personnel are permitted to perform activities such as transport, installation, commissioning and maintenance. Properly qualified persons are those who are familiar with transport, installation, assembly, commissioning and operation of the products, and who have the appropriate qualifications for their job. The qualified personnel must know and observe the following standards and directives:
IEC 364 and CENELEC HD 384 or DIN VDE 0100
IEC Report 664 or DIN VDE 0110
national accident prevention regulations or BGV A2**
- ◆ **Read the available documentation before carrying out installation and commissioning. Incorrect treatment of the servo amplifier can lead to injury to persons or material damage. It is vital that you keep to the technical data and information on connection requirements nameplate and documentation).**
- ◆ **The servo amplifiers contain electrostatically sensitive components which may be damaged by incorrect handling. Discharge your body before touching the servo amplifier. Avoid contact with highly insulating (artificial fabrics, plastic film etc.). Place the servo amplifier on a conductive surface.**
- ◆ **Do not open the units. Keep all covers and switchgear cabinet doors closed in operation. Otherwise there are deadly hazards with the possibility of severe danger to health or material damage.**
- ◆ **In operation, depending on the degree of enclosure protection, servo amplifiers can have bare components which are live and hot surfaces. Control and power cables can carry a high voltage even when the motor is not rotating.**
- ◆ **Never undo the electrical connections of the servo amplifier when it is live. There is a danger of electric arcing and danger to persons and contact. Wait at least two minutes after disconnecting the servo amplifier from the mains supply voltage before touching live sections of the equipment or undoing connections (e.g. contacts, screwed connections). Capacitors can have dangerous voltages present up to two minutes after switching off the supply voltages. To be sure, measure the voltage in the intermediate circuit and wait until it has fallen below 40V.**

Directives and standards

Servo amplifiers are components which are intended to be incorporated into electrical machines and plant.

When the servo amplifiers are incorporated into machines or plant, the intended operation of the amplifiers is forbidden until it has been established that the machine or plant fulfills the requirements of the EC Directive on Machines 89/392/EEC and the EC Directive on EMC 89/336/EEC. EN 60204 and EN 292 must also be observed.

In connection with the Low Voltage Directive 73/23/EEC, the harmonized standards of the EN 50178 series are applied to the servo amplifiers, together with EN 60439-1, EN 60146 and EN 60204.

The manufacturer of the machine or plant is responsible for ensuring that the machine or plant meets the limits which are laid down by the EMC regulations. Advice on the correct installation for EMC – such as shielding, grounding, arrangement of filters, treatment of connectors and laying out the cabling – is included in the documentation of the used servo amplifier.

I General Information

I.1 Preface

This manual explains the installation and application of the operator software BS7200 for the digital servo amplifier **digifas™ 7100/7200**.

It describes all the parameters, their modes of operation and the methods of optimizing the drive with the aid of the operator .

The manual is divided into 5 chapters:

- Chapter 1: General Information
- Chapter 2: Installation /Screen layout / Operation
- Chapter 3: Description of parameters
- Chapter 4: Drive optimization
- Chapter 5: Appendix



Knowledge of the MS-DOS operating system and the use of a personal computer is assumed. You must follow the safety, installation and commissioning instructions in the installation manual for the particular servo amplifier which is used.

We provide training and familiarization courses on request.



Only professional staff with extensive knowledge of drive and control technology are allowed to use the operator software (or the operating keys) to alter the operational parameters of the servo amplifier.

I.2 Further documentation

Installation manual for the digifas™ 7100 servo amplifier	Order no.	83498
Installation manual for the digifas™ 7200 servo amplifier	Order no.	83003
Digital interfacing with the automation system:		
Technical description BIT CONNECT	Order no.	83108
Technical description PROFIBUS CONNECT	Order no.	83106
Technical description PULSE CONNECT	Order no.	83109
Technical description CAN CONNECT	Order no.	83105

All the operating manuals for the component parts are delivered together with the amplifier.

I.3 Use as directed

The BS7200 software is intended to be used to alter or to store the operational parameters of the digifas™ series of servo amplifiers. The servo amplifiers which are connected are commissioned with the aid of the software. During this procedure the drive is under the direct control of the service functions.

Online parameterization of a drive which is running is only permissible for professional personnel.



The software does not provide any personal or material safety. You must therefore ensure that the higher level control provides a safe monitoring of the drive. Prepare a hazard analysis of your machine.

Data sets which are stored on data media are not safe from undesired alteration by third parties. After loading a set of data it is therefore necessary to check all parameters thoroughly before enabling the servo amplifier.

I.4 Abbreviations used

Abbrev.	Meaning	Abbrev.	Meaning
COM	Serial interface of a PC-AT	MS-DOS	Operating system for PC-AT
Disk	Magnetic storage (diskette, hard disk)	PC-AT	Personal computer with 80x86 processor
EEPROM	Electrically erasable read-only memory	RAM	Volatile memory
LPT	Parallel interface of a PC-AT	VGA	Graphics output with at least 640x480 pixels
MB	Megabyte (1 million bytes)		

I.5 Software description

The digital servo amplifiers of the digifas™ 7100/7200 series must be adapted to the characteristics of your machine. Do not carry out the parameterization directly on the amplifier, but with the aid of the operator software BS7200, running on a personal computer. The PC is connected to the servo amplifier by a special cable. The operator software establishes the communication between the PC and the digifas™, and exchanges data and instructions.

You will find the operator software on the enclosed diskette.



Keep the diskette safe in a place which is protected from dust, dampness, magnetic fields and extreme temperatures.

Never put the diskette in a switchgear cabinet or a cable duct.

The magnetic fields in such areas may destroy the magnetization of the diskette.

Use only a copy of the original diskette on site.

You can change all the parameters, with very little effort, and instantly observe the effect on the drive, since there is a continuous on-line connection to the amplifier .

Important process values (actual values) are simultaneously read in from the amplifier and displayed on the monitor of the PC.

Any interface modules (CONNECT modules) which are built in to the amplifier will be automatically recognized and the additional parameters which are required for positional control or a motion block will be made available.

If there is no amplifier connected to the PC then it is still possible to start the software, but the response to keyboard entry will be considerably delayed, because every attempt at communication between the PC and the amplifier will result in a time-out error message after the maximum waiting time. In this case, use the "Offline editing" mode (menu page: Handling). In this mode the communication is switched off and you can work without any delays.

Sets of data can be stored on data storage media (for archiving) and loaded again. Data sets on storage media can also be printed out.

We provide motor-oriented default data sets for all plausible combinations of servo amplifier and motor (6SM motor series). In many applications you will be able to use these default values to commission your drive without any problems .

I.6 Hardware requirements

The PC-interface (X6) of the amplifier is connected to the parallel or serial interface of the PC by a special 9-core cable.



Disconnect / connect the cable only while all supply voltages are switched off.

In the amplifier, the interface is electrically isolated by optocouplers.

Connection to a parallel interface

Use our special 9 poles parallel communication cable. Because of the variable specifications for the parallel interface in PCs (especially in laptop or notebook computers) it is possible that the line drivers in many PCs are unable to provide enough power to switch the optocouplers in the amplifier. In this case it is necessary to wire in an additional line driver with an external power supply.

We can supply such a unit, with a power supply, together with the interface cable.

Connection to a serial interface

Use our special 9 poles serial communication cable with power supply.

The minimum requirements for the PC are as follows:

Processor	:	80386 or higher
Clock	:	16 MHz or higher
Operating system	:	MS-DOS (3.3 or higher)
Graphics card	:	VGA
Monitor	:	b/w or colour
Drive	:	3.5" diskette drive, hard disk (drive letter C:)
Main memory	:	at least 1 MB, there must be at least 400 kB of contiguous memory available in the conventional (640 kB) memory area.
Interface	:	one available parallel interface (LPT1:, LPT2:, COM1: or COM2:)
		LPT1 : address 378H COM1 : address 3F8H
		LPT2 : address 278H COM2 : address 2F8H
System setup (config.sys)	:	buffers: min. 30 files : min. 30 stacks: 0,0 or not defined environment: define the environment size (/E:xxxx) – at least 1024 byte – of the command interpreter. The correct syntax is: shell=command.com /E:1024 with the path for command.com, if necessary

Creating a boot disk

We provide a program "BOOTDISK" to enable you to create a special boot disk, in case you are unable to make the above alterations to the system settings of your PC yourself.

Further information on this topic can be found in Chapter II.3 .

I.7 Communications cable: digifas™ ↔ PC (parallel interface)

This cable is provided by us, ready-made, with a length of 2m. We recommend that you use this ready-made and tested cable. Experience shows that copies often cause problems.



We can only guarantee reliable data transmission between digifas™ and the PC if you use our ready-made cable.

The basic connector layout and pin assignments are shown below:

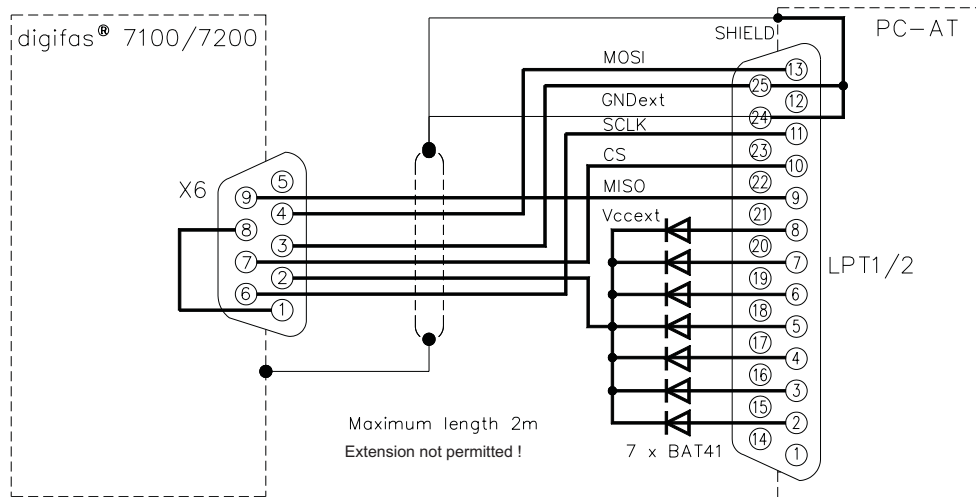

I.8 Communications cable: digifas™ ↔ PC (serial interface)

Never use a standard serial cable !

The communication only works with our special cable with power supply.

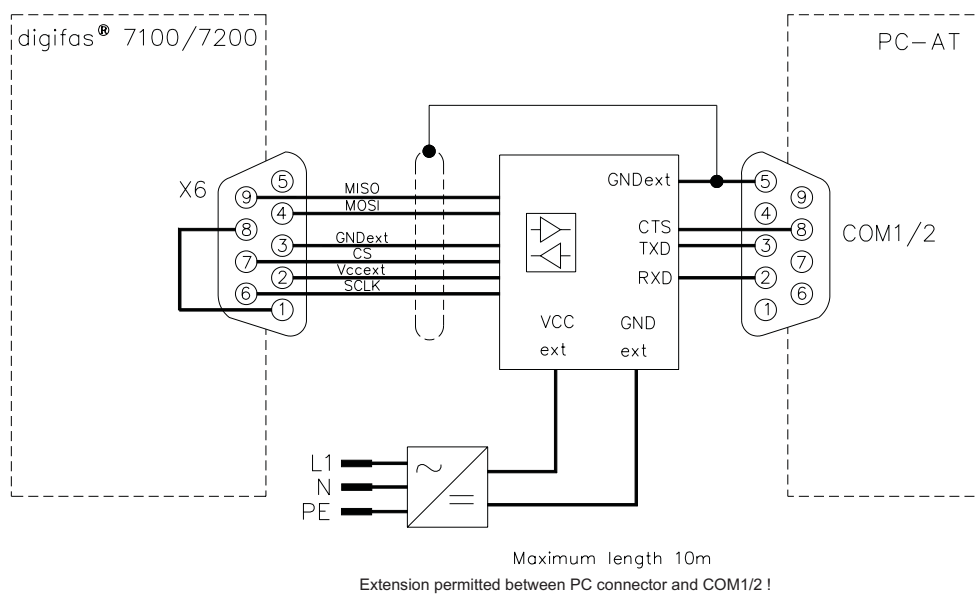

II Installation / Operation

II.1 Installation under DOS



First check that your PC fulfills the system requirements (see Chapter I.6).

The operator software will be found on the enclosed diskette, with the name

BS7200.EXE

The diskette also includes an installation program called **SETUP.BAT**, which makes it easier for you to install the operator software onto your PC.

Connection to a parallel Port of the PC:

Plug in the communications cable (with the 25-pin SubD male) to a parallel port (printer interface) on your PC, and plug the 9-pin SubD connector into the PC interface of the digifas™.

Connection to a serial Port of the PC:

Plug in the communications cable (with the 9-pin SubD female) to a serial port on your PC, and plug the 9-pin SubD connector into the PC interface of the digifas™.

Switch on :

Switch on the PC-AT and the monitor.

After booting up, the MS-DOS prompt will appear on the screen, usually as the ">" symbol.

Take the diskette which contains the operator software out of its protective sleeve and insert it into the slot of the diskette drive.

Enter the following commands on the keyboard:

a: (or **b:**) Select diskette drive A or B, according to which one holds the diskette.

 *Press Return*

setup Start of the installation program

 *Press Return*

The installation program will now create a directory called DIGIFAS on your C drive, with subdirectories called DAT and DEFAULT, and will copy the program and the files of default values to the corresponding directories.

II.2 Program start

When the SETUP program has finished you will be in the directory C:\DIGIFAS

bs7200 LPT1 Call the program BS7200.EXE when the connection is to LPT1:

bs7200 LPT2 Call the program BS7200.EXE when the connection is to LPT2:

bs7200 COM1 Call the program BS7200.EXE when the connection is to COM1:

bs7200 COM2 Call the program BS7200.EXE when the connection is to COM2:

 *Press Return*

The operator software has now been installed and started.

To exit the operator software : press the ESC key and confirm the query with "Y"

If the program does not function, the computer crashes, or unexpected effects occur, then you should use the program BOOTDISK.COM to create a boot disk (see Chapter II.3)

II.3 Creating a boot disk

If the BS7200 program does not function, the computer crashes, or unexpected effects occur, then you should use the program **BOOTDISK.COM** to create a boot disk. The system configuration of your PC is probably not suitable for working with BS7200.EXE.

Insert a blank, formatted diskette into the A: drive.

Start the **BOOTDISK.COM** program. This program copies the operating system files from your hard disk to the diskette. Two start files which we have created (config.sys and autoexec.bat) are also copied to the diskette.

You now have a bootable diskette which will start your PC with a minimal system configuration.

Now press the RESET button on your PC. The PC will start up with the system configuration which is on the diskette. The BS7200 operator software will be started automatically.

When you close the BS7200 program you will find yourself to be in the C:\DIGIFAS directory.

If you want to start up the PC in the original configuration, remove the diskette from the A: drive and operate the RESET button again. The PC will now start up with the system configuration which is on the hard disk.

II.4 Other operating systems

WINDOWS 3.xx and WINDOWS 95

BS7200.EXE is a DOS program. You can only run it under WINDOWS as a full-screen DOS session, not in a window. Please consult the WINDOWS documentation.

WINDOWS NT

BS7200.EXE is not executable under WINDOWS NT.

OS2

BS7200.EXE ist not intended to be used under OS2.

Network

BS7200.EXE is not intended to be used in networks.

II.5 Screen Layout

The screen layout is shown below, using the "SPEED" menu page as an example.

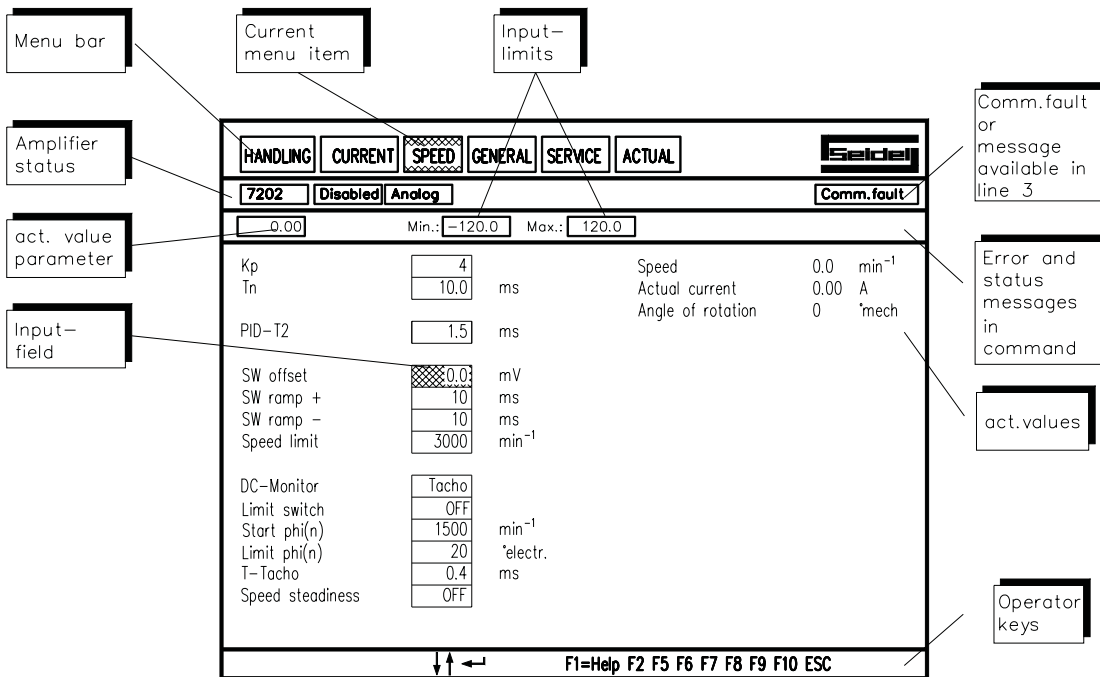

- Menu bar (line 1)** : All the screen pages which can be selected are displayed in clear text in the header line of the screen.
- Current menu item** : The current menu selection is shown in a different colour.
- Input limits** : If a parameter is selected (e.g. "SW Offset"), then the permissible limits for the input are shown here.
- Amplifier status (line 2)** : Displays the current servo amplifier status.
Interpretation of the field at the far right:
 - Comm.fault** Communications fault amplifier ↔ PC
 - Ampl.fault** In input mode: indicates the availability of a detailed error message in the third line of the screen.
This detailed message in the error/status line is only visible in the command mode.
 - Status** : In input mode: if a situation occurs which would affect the functioning of the drive, this indicates the availability of a detailed error message in the third line of the screen.
This detailed message in the fault/status line is only visible in the command mode.
 - Offline** : Parameter Offline editing is set to "on".
The parameters which are displayed will no longer be transferred to the digifas™ .
- Input field** : Input field for altering parameters (only in input mode)
- Act. value parameter** : Display field for parameters (only in input mode)
- Error/Status line 3** : Servo amplifier faults, communications errors and status-messages which would affect operation are displayed in this line (only in command mode).
- Actual values** : Actual values of the servo amplifier are displayed in on-line mode.
- Operator keys** : The operator keys which are currently available for use.

II.6 Operation

The opening screen appears after the start of the operator program. Please observe the safety and commissioning instructions in the instruction manual for the servo amplifier before using the operator software.

Press the key.

The standard screen page now appears and the menu item "HANDLING" is active. You are now in the command mode. A distinction is made between command and input mode.

In **command mode** a menu item can be selected. Use the ALT key for this purpose, hold it down and **in addition** press the key with the underlined letter for the desired menu item (e.g. ALT-C for the CURRENT menu). After selecting a menu item you will still be in the command mode. You can reach the command mode from within the input mode by using or the function key F10.

Parameters can be altered in the **input mode**. After altering a parameter you will still be in the input mode. You can reach the input mode from the command mode by pressing the or keys.

It is possible to switch directly from the input mode to a different screen page (corresponding to the selection of a menu item in the command mode). To do this, press the ALT key, hold it down, and **in addition** press the key with the underlined letter for the desired menu item.

If you are in input mode (i.e. a parameter field is marked by a colour), you can access the previous or following parameters by pressing the or keys.

There are different types of parameter:

Numerical parameters —	e.g. SW1 Offset in the SPEED menu page. The input field appears at the left in the third line of the screen. The input limits are displayed in the middle of this screen line. Input: Digits and point as decimal characters. Press <input type="button" value="↵"/> to confirm the entry.
Selection parameters —	e.g. DC Monitor in the SPEED menu page. These parameters are identified by a small triangle in front of the parameter field (if it has been selected). No input field appears. The available options are displayed in the middle of the third line of the screen. Input: Selection by using the <input type="button" value="+"/> or <input type="button" value="-"/> keys. The spacebar can also be used, instead of the <input type="button" value="+"/> key.
Function calls —	e.g. "save to EEPROM" on menu page "Handling". The function is started by entering <input type="button" value="↵"/> . Safety queries prevent accidental execution.

All entries are subjected to a plausibility check. If the result is not satisfactory the entry is rejected and the error is displayed (at the right of the third screen line). If the entry is plausible the new value is transferred to the servo amplifier RAM. After the successful transfer the entered value is transferred to the display field for the parameter and then becomes effective.

End program	—	in command mode:	press the ESC key
	—	in input mode:	press the F10 key, then ESC or two times ESC

II.7 Function keys

The **usable** function keys are displayed in the bottom line of the screen, depending on the program status. These keys are assigned to the following functions:

- F1 key** : **Help.** Input mode : The help text which refers to the current parameter appears in the lower right quarter of the screen.
 Command mode : Display general information.
- F2 key** : **Parameter update.** The parameters are freshly transferred from amplifier to PC.
- F5 key** : **Constant direct current.** The drive is run with the preselected parameters "Setpoint" and "electr. angle" from the "SERVICE" menu page. "I_DC" appears in the third field of the status line. This function remains active until the function key F9 is pressed.
- F6 key** : **Constant speed.** The drive is operated at the predetermined speed given in the "SERVICE" menu page. "N_CONST" appears in the third field of the status line. The function remains active until the function key F9 is pressed.
- F7 key** : **Constant current.** The drive is operated with the current (1:1) which is selected in the "SERVICE" menu page. "I_CONST" appears in the third field of the status line.
 The function remains active until the function key F9 is pressed.
- F8 key** : **Reversing mode.** The drive is operated with the preselected "Setpoint" and "Time" parameters in the "SERVICE" menu page.
 "REVERS" appears in the third field of the status line.
 The function remains active until the function key F9 is pressed.
- F9 key** : **Stop (OFF):** The functions F5, F6, F7 and F8 are switched off by using this key.
- F10 key, ESC:** End input mode, change to the command mode.

Any confirmation queries appear in the third line of the screen. Answer the queries by using the Y for YES or the N key for NO.



**Only use the F6, F7 and F8 functions when you are sure that the movement of the drive cannot lead to any hazard for persons or machinery.
 Before answering the confirmation query with YES, check whether the parameters which have been entered for the function in the "SERVICE" menu page are correct.**

II.8 Status line, screen line 2

The current status of the servo amplifier which is connected is continually displayed in eleven fields in the status line (second screen line). The line is structured as follows, from left to right:

- Field 1** : Type of servo amplifier
Field 2 : State of the ENABLE input
Field 3 : Operating mode: displays the type of the integrated interface module or the performance of a test function (F5, F6, F7 or F8 keys)
Field 4 : State of the BTB output of the servo amplifier
Field 5 : not used
Field 6 : not used
Field 7 : Displays whether the ballast capacity has been exceeded
Field 8 : Displays whether the I²t threshold has been exceeded
Field 9 : State of the In-Position output (only with an integrated interface module)
Field 10 : not used
Field 11 : Communication fault, notification of an error message, or other status messages in line 3 in command mode (see Chapter II.9).

II.9 Error and status messages, screen line 3

In command mode, error messages and status messages which restrict operation are displayed in the third line of the screen. In input mode the general message “**Ampl. fault**” or “**Status**” appears in field 11 of the status line. After changing to the command mode (**F10**) the detailed messages appear in the third line of the screen. The screen line is built up dynamically, the Error/status messages appear in the order of their weighting.

Error messages (listed in the weighting order):

Outp.stage	Fault in the output stage
Resolver	Resolver error
Undervolt.	Undervoltage in the intermediate voltage (DC link)
Overvolt.	Overvoltage in the intermediate voltage (DC link)
Earth_fault	Motor short-circuit to earth (only for digifas™ 7200)
Brake	Brake fault (cable break or similar)
Mains_BT B	Mains-BTB (no significance)
Heat_sink	Heat sink temperature too high
Intern.temp	Internal temperature too high
Motor_temp	Motor temperature too high
EEPROM 1	Read error internal EEPROM. All parameters have been set to 0 !
EEPROM 2	Read error CONNECT-interface EEPROM. CONNECT parameters=0 !
Time-out	Time-out for the field-bus master station.
Motor cable	Phase U or phase V of the motor cable is interrupted
LCA	internal message

All error messages result in the opening of the BTB-contact and the switch-off of the output stage of the servo amplifier (no motor current and torque).
If a brake is fitted and selected, then the brake will be activated.

Status messages (listed in the weighting order):

PSTOP	message hardware limit switch for positive (CW) rotation
NSTOP	message hardware limit switch for negative (CCW) rotation
Cont.error	message contouring error (with integrated CONNECT interface)
Soft-End-1	message software limit switch 1 (with integrated CONNECT interface)
Soft-End-2	message software limit switch 2 (with integrated CONNECT interface)

II.10 Actual-value display

The actual values which are read in on-line from the amplifier are displayed at top right of all screen pages (apart from the “HANDLING” page):

Speed	actual speed of the motor
Actual current	actual effective current output (active current)
Angle of rotation	actual angle of rotation of the rotor (only for n < 20 rpm, see III.6)

The following actual values are displayed on the HANDLING screen page:

Directory	Current directory on the hard disk
Serial number	Serial number of the servo amplifier
Software basic unit	Version of the servo amplifier software
Software PC	Version of the operator software
Interface number	Serial number of the CONNECT interface, if present
Software interface	Version of the interface software (PROFIBUS or CAN), if present
Last data set	File name of the data set saved last in the EEPROM.

III Description of parameters

III.1 Menu page “Handling”

III.1.1 Save to EEPROM

Permanent storage of the current parameter set in the EEPROM of the servo amplifier.

Input : Return

After operating the  key, the confirmation query “Execute function Y/N ?” appears. If you reply with “Y”, then the function will be performed.

This function is used to write the current parameter set from the servo amplifier RAM to the EEPROM. In this way all the parameter changes which you have made since the last switch-on or reset of the servo amplifier are stored permanently.

III.1.2 Edit Offline

Even when no servo amplifier is connected, you can still display and process data sets.

To do this, set the parameter “Offline Editing” to ON. Use the command “Load from disk” to load a set of data. Now you can set all the parameters as usual, and then “Save to disk” to store the data set.

If you have loaded a set of data and then set the parameter “Offline Editing” to OFF, then the data set which has been loaded will be discarded. If a servo amplifier is connected, then the parameters which are stored in the servo amplifier will be read and displayed.

The status “OFFLINE” is displayed in field 11 of the status line (2nd line, at right).

Selection : ON, OFF



If you have saved data sets with the software version 6L40, or older, and then edit them “Offline” with operator software 7L20, then some program settings will be set automatically, since the appropriate information is missing from the old data sets.



III.1.3 Select directory

Selection or creation of a directory on the hard disk.

Input : Return

Default setting on delivery: "DAT" directory.

Choose the selection or creation of the current directory on the hard disk.

Select: Choose one of the first 10 stored directories from the selection window, using the  or  keys and confirm by pressing . If more than 10 directories are available, use the **Page↓** or **Page↑** keys to go to the previous/following directories.

Create: Define a name for the directory (max.8 characters: A-Z, 0-9). If the name is correct, then, after a confirmation query, the directory is created and becomes current.

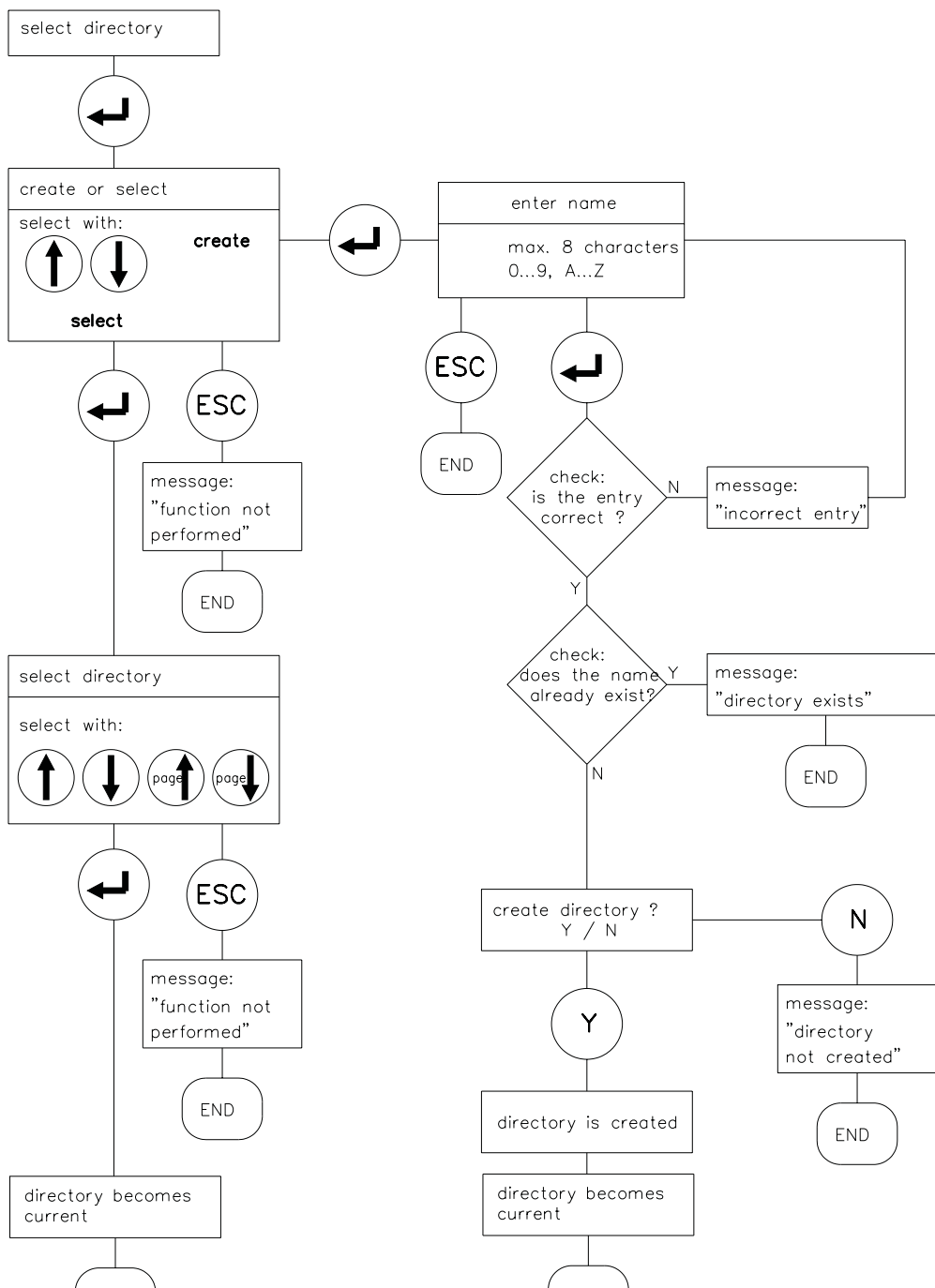

III.1.4 Save to disk

Saves the current parameter set to the current directory on the hard disk.

Input: Return



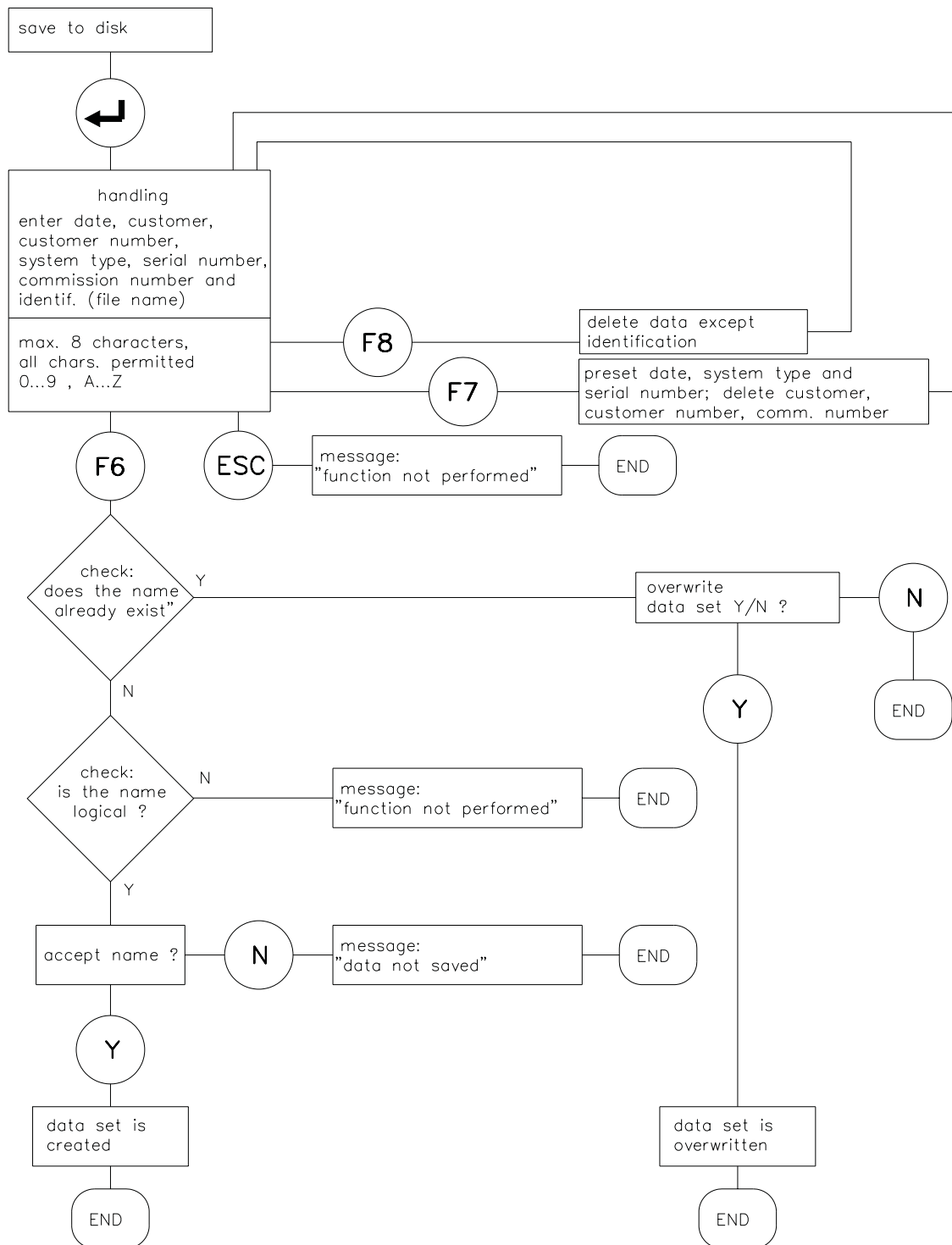

Complete the input form (name of the data set :max. 8 characters 0...9, A...Z).
After operating the key, there is a check whether a data set with this name already exists. If not, then the name is stored, if there is, then the confirmation query appears "Overwrite data set Y/N". If you reply with "Y", then the data set will be overwritten.
See the flow diagram below for the functional procedure.



III.1.5 Load from disk

A set of data is read from the data bank on the current hard-disk directory and becomes the current (active) set.

Input: Return **the servo amplifier must be disabled**

Make your selection in the selection window with the first 10 stored data sets, using the  or  key, and accept with . If more than 10 data sets are available, then change to the previous/following page by using **Page** or **Page**. The selection can be rejected by using the **ESC** key.

If the type of servo amplifier does not match the selected data, then an error message appears and the data will not be loaded.

For permanent storage of the data in the servo amplifier:
perform the function "SAVE TO EEPROM".

Functional procedure: see the following flow diagram.





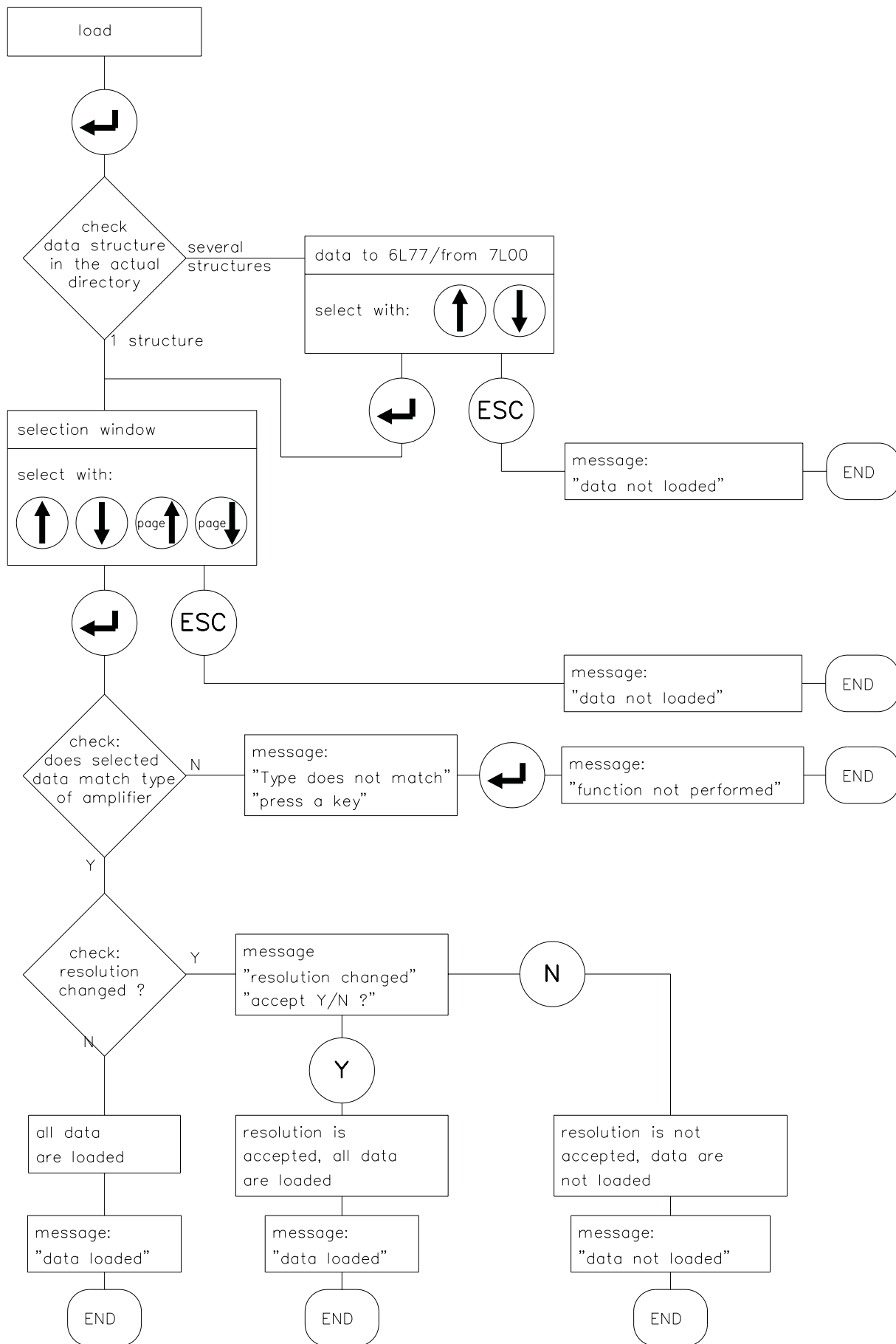

Data sets which are stored on data media are not safe from unwanted alterations by third parties. After loading a set of data it is therefore necessary to check all parameters thoroughly before enabling the servo amplifier.



III.1.6 Load default settings

The default data sets which we provide for certain servo amplifier – motor combinations can be loaded into the RAM from a data bank on the hard disk.

Input : Return **servo amplifier must be disabled, Offline Editing = OFF**

Make your selection in the selection window with the first 10 stored data sets, using the  or  key, and accept with . If more than 10 data sets are available, then change to the previous/following page by using **Page** or **Page**. The selection can be rejected by using the **ESC** key.

If the type of servo amplifier does not match the selected data, then an error message appears and the data will not be loaded.

The data bank is continually being expanded. The current date of the default data bank can be seen to the right of the selection window.

For permanent storage of the data in the servo amplifier, use the function "SAVE TO EEPROM".

Functional procedure: see the following flow diagram.



Data sets which are stored on data media are not safe from unwanted alterations by third parties. After loading a set of data it is therefore necessary to check all parameters thoroughly before enabling the servo amplifier.

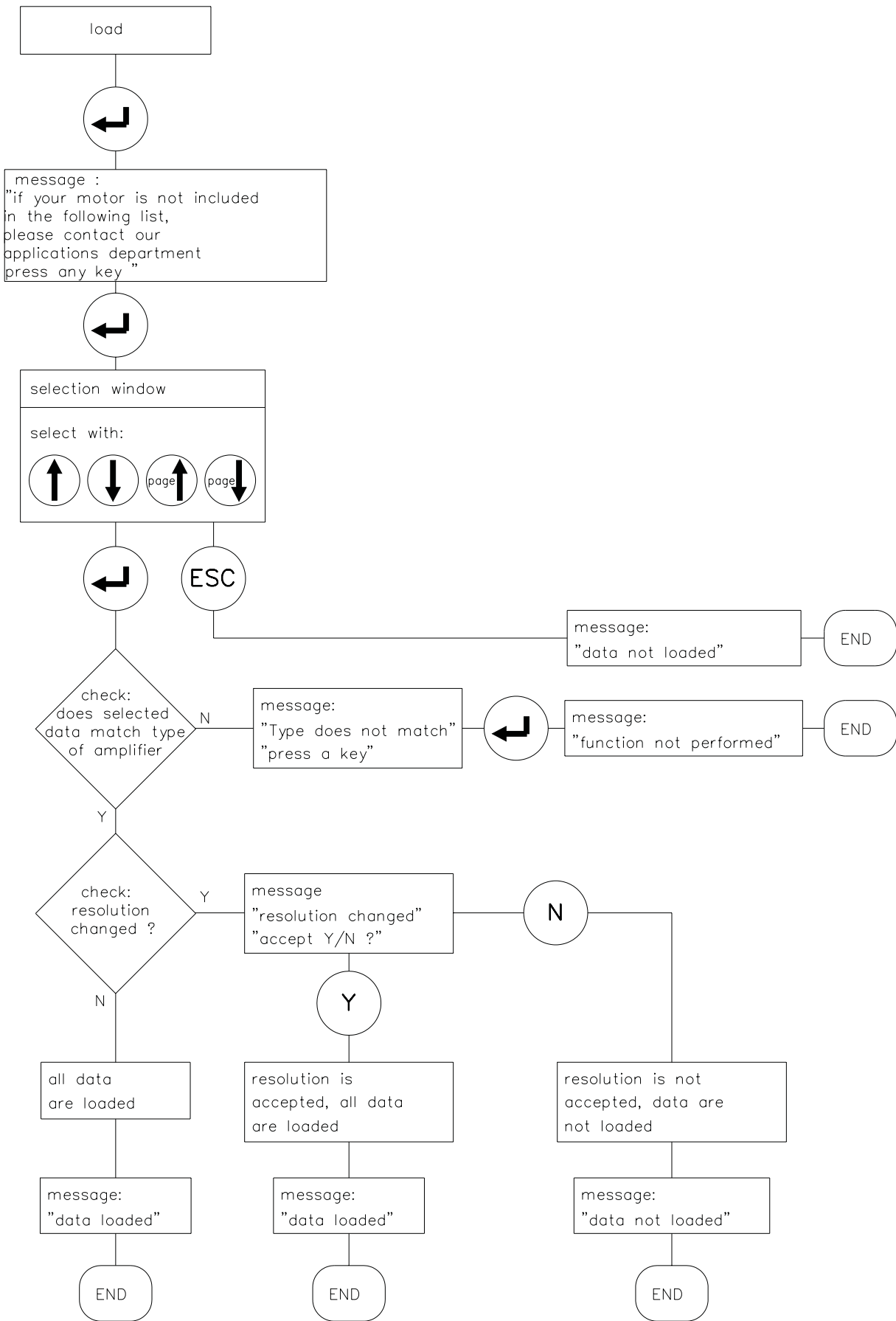

III.1.7 Print parameters

Data sets which are stored on disk can be printed out. You can select whether the printer data are sent to a parallel port (LPT1 or LPT2) or saved as a file in the current directory. You can use just about any commercially available printer – the data are output in 8-bit ASCII format. The function “Print parameters” can only be selected when the parameter “Offline editing” is set to ON.

For functional procedure: see flow diagram below.

Input : Return

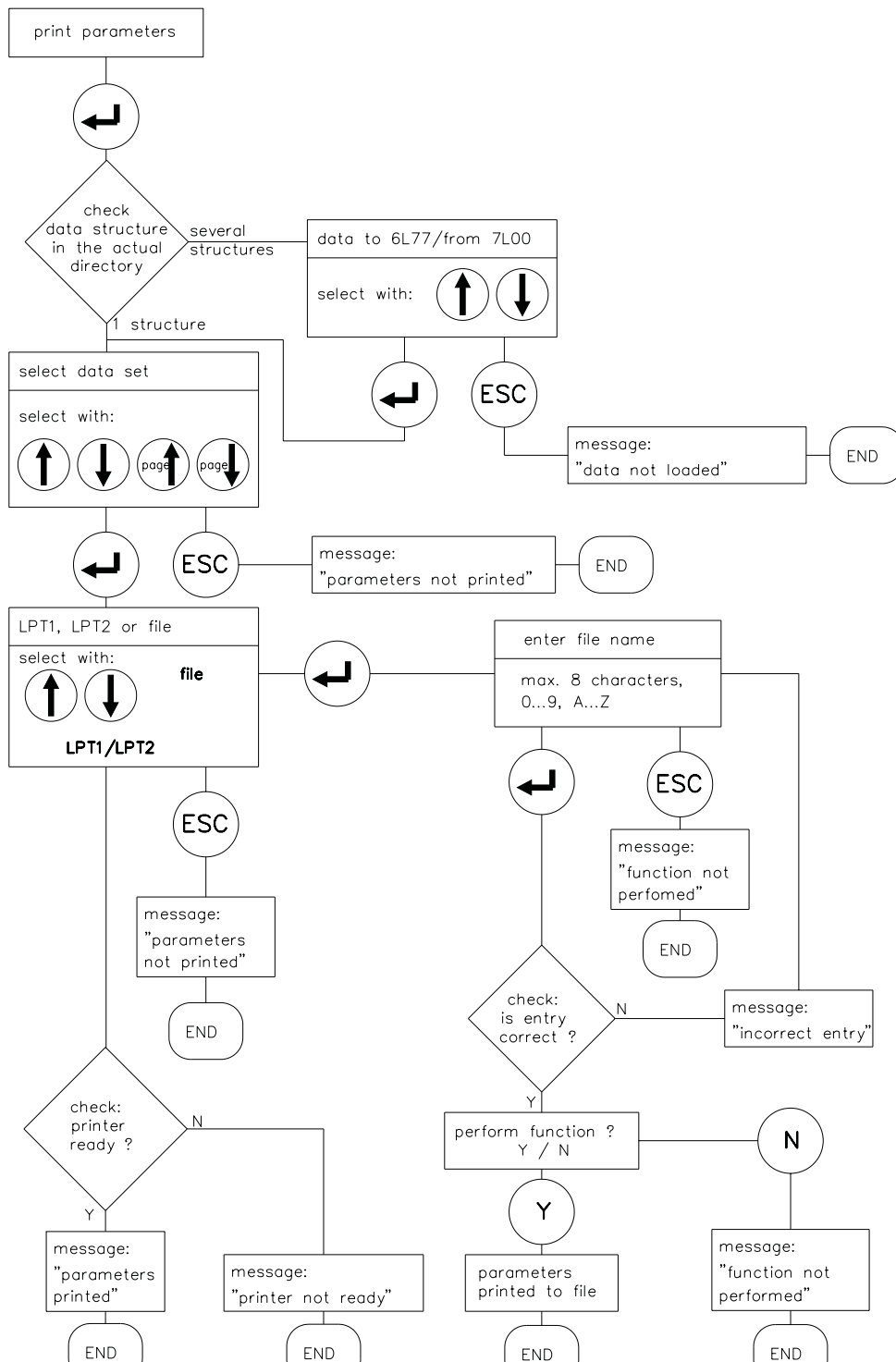

III.2 Menu Page "Current controller"

III.2.1 I_{rms} , effective current

This parameter sets the required nominal output current. The value is usually set to the quiescent current I₀ of the attached motor. The upper limit is set automatically, depending on the type of servo amplifier.

This function is used to monitor the actual rms current required. The limit which is defined by the I_{rms} setting will respond after approx. T_{I2t} = 5s at maximum load. The conversion formula for current settings which diverge from the rated values is:

$$T_{I2t} = 20s * \left(\frac{I_{rms}}{I_{peak}} \right)^2$$

Input : 0,1A...nominal output current of the servo amplifier

Effects: Value too low — drive shows a contouring error, torque too low
 Value too high — motor may be thermally overloaded

III.2.2 I_{peak}, peak current

This parameter sets the required peak output current (effective value). The upper limit is set automatically, depending on the type of amplifier.



The permissible peak motor current I_{0max} must not be exceeded in any circumstances!

Input : 0,2 x ... 2 x the rated servo amplifier current

Effects: Value too low — Drive shows a contouring error, peak torque is too low
 Value too high — Drive is at risk

III.2.3 I²t message

This sets a percentage (0 ... 100 %) of the effective current which, if exceeded, results in a signal at the programmable I/O output (terminal X3/15).

Input : 0...100 %

Effects: Value too low — Message appears too early, drive is under-used
 Value too high — Limiting appears simultaneously with the message

III.2.4 K_p, P-gain

Determines the proportional gain (0.1 ... 8) of the current controller.



Only alter this parameter if no other measure produces the required control characteristics.

Call our Service Department for further information.

III.2.5 T_n, integration time

Determines the integration time constant or reset time (0.1 ... 10 ms) of the current controller.



Only alter this parameter if no other measure produces the required control characteristics.

Call our Service Department for further information.

III.3 Menu page "Speed controller"

III.3.1 Kp, P-gain

This parameter defines the proportional gain (also called AC-gain). Increasing the value until the motor is on the verge of oscillation and then reducing it well below this threshold to avoid oscillation. Typical settings are between 10 and 20.

Input : 0,1...63

Effects: Value too low — drive is too soft, poor damping
Value too high — drive whistles or runs roughly

III.3.2 Tn, integration time

Determines the integration time constant. Small motors permit shorter time constants (5...10ms), larger motors or large inertial mass moments usually require time constants of 20 ms and more. An entry of 1000 ms effectively turns off the I component.

Input : 0,1...1000 ms

Effects: Value too low — drive runs roughly, strong overshoot with high external moments of inertia
Value too high — drive is too soft

III.3.3 PID-T2, second time constant

This parameter affects the P-gain at medium frequencies. The **damping** of the speed control loop can often be improved by increasing PID-T2 to $T_n/3$. If this setting (0.2 ... 25 ms) is necessary it is made after the basic setting of K_p and T_n .

Input : 0,2...25 ms

Effects : Value too low — drive is too stiff
Value too high — not stiff enough

III.3.4 SW offset

This parameter is used to compensate for the offset voltages in the CNC-control and the analogue input. The adjustment is made when the axis is stationary and the setpoint = 0 V.

Input : -120 ...+120 mV

Effects : Value not correct — axis drifts, even when setpoint = 0 V

III.3.5 SW ramp +

This parameter delays the rate of rise of the setpoint input during **acceleration** in both directions by the time entered (up to the maximum value). An advantageous smoothing / limiting of rate of change is the result in the event of abrupt changes or steps in the setpoint input. The reaction time of the system will not be impaired, as long as the ramp time is smaller than the mechanically limited rise time of the system.

Input : 2...6300 ms.

Effects : Value too low — ramp function is practically ineffective
Value too high — ramp function produces contouring errors

III.3.6 SW ramp -

This parameter delays the rate of fall of the setpoint input during **braking** in both directions by the time entered (up to the maximum value). An advantageous smoothing / limiting of rate of change is the result in the event of abrupt changes or steps in the setpoint input.

The reaction time of the system will not be impaired, as long as the ramp time is smaller than the mechanically limited fall time of the system.

Usually, SW ramp + and SW ramp – can be set to the same value

Input : 2...6300 ms.

Effects : Value too low — ramp function is practically ineffective
Value too high — ramp function produces contouring errors

III.3.7 Speed limit

Defines the scaling of the speed feedback. The speed limit is reached at the maximum setpoint input of ± 10 V.

The maximum value depends on the number of resolver poles which is set.

no. of resolver poles	max. speed limit
2 (without CONNECT)	8000 rpm
2 (with CONNECT)	6000 rpm
4 (without CONNECT only)	6000 rpm
6 (without CONNECT only)	4000 rpm



This setting affects the adjustment of Kp, so the speed limit should be fixed before the other parameters are adjusted.

Input : 800...8000 rpm

Effects : Value too low — the required speed limit cannot be reached even at ± 10 V setpoint input
Value too high — the set speed limit cannot be reached, because of the limited intermediate (link) voltage. The amplifier cuts out.

III.3.8 DC monitor

The output IDC/VTA (terminal X3/23) provides according to the selection in the operator software several actual values. The output resistance is 2.2 k Ω , the resolution is 10 bits.

Input : Current / Tacho / S_fault / I_set

Current

The IDC-monitor provides ± 10 V for \pm **peak unit current** (rms sine-wave value) referred to AGND. The output is the non-phase related actual value of current, which is approximately **proportional** to the **motor torque** which is produced.

Tacho

The output provides ± 10 V referred to AGND at the set speed limit.

The scaling of SW and VTA is therefore identical.

S_fault (devices with CONNECT interface only)

The output provides ± 10 V for the set contouring error referred to AGND.

I-set

The output provides ± 10 V for the internal current setpoint (equivalent to \pm equipment peak current at the output of the speed controller) referred to AGND.

III.3.9 Limit switch / Stop

The PLC-compatible limit switch inputs can be activated (ON) or deactivated (OFF). An L-signal on the input terminal PSTOP (terminal X3/10) or NSTOP (terminal X3/11) disables the corresponding direction of rotation. For units without a CONNECT module (i.e. without a position control) braking is made down the setpoint ramp which has been set.



The limit switches must remain activated until the motor is at standstill.

L-signals on both inputs brake the motor down to a stop. With ON, the motor stops without being under servo-control. With STOP, the motor stops under drift-free control with standstill torque M_0 .

Input : ON / OFF / STOP

Effects :	Off	—	limit switch function is switched off
	On	—	limit switch function is on, motor brakes and stops, no servo control, mechanical release (from stop) permitted
	Stop	—	limit switch function is switched on, motor stops drift-free with standstill torque M_0

III.3.10 Start Phi, phase shift

The inductive phase shift between the motor current and motor voltage at high speeds can be compensated. Under defined voltage conditions this produces a higher torque at the speed limit. Alternatively, the speed limit which can be achieved can be increased by up to 50 %.
Input limits: 0 ... speed limit in rpm

Input : 0...80% of the set speed limit in rpm

Effects :	Value too low	—	motor utilization is worse
	Value too high	—	effect is inadequate

III.3.11 Limit Phi, phase shift

The phase shift is increased (depending on the motor speed) linearly from the Start Phi value up to the final value = Limit Phi. The optimum setting depends on the motor type and the speed limit.

Input : 0...45 °electrical

Effects :	Value too low	—	effect is inadequate
	Value too high	—	motor utilization is worse, very high idle current

III.3.12 T-Tacho, actual speed value filter

The time constant of the PT1 filter in the actual speed feedback (tacho smoothing) can be altered if required. This can produce an improvement in the quietness of running and step response, especially for small, highly dynamic motors.

Input : 0,2 ... 100 ms

Effects :	Value too low	—	motor runs roughly
	Value too high	—	speed regulation becomes soft and unstable

III.3.13 Speed steadiness

Improves the smooth running qualities for drive applications with a constant speed.

Entry : OFF / ON

III.4 Menu page "General"

III.4.1 Language

Selection of operating language. **Input :** German, English, French

III.4.2 No. of motor poles

The current waveform input can be selected to drive motors with 2 to 12 poles. The motors in the 6SM series have 6 poles.

This parameter can only be changed while the amplifier is disabled

(Enable=0).

Input : 2,4,6,8,10,12

Permitted combinations of no. of motor poles/speed :

No. of motor poles	No. of resolver poles	maximum speed limit
2, 4, 6, 8, 10, 12	2 (withou CONNECT)	8000 rpm
2, 4, 6, 8, 10, 12	2 (with CONNECT)	6000 rpm
4, 8, 12	4 (without CONNECT only)	6000 rpm
6, 12	6 (without CONNECT only)	4000 rpm

III.4.3 No. of resolver poles

Standard resolvers have 2 poles. It is possible to switch over to the use of special versions with 4- and 6-poles. **This parameter can only be changed while the servo amplifier is disabled.**

(Enable=0). **Input :** 2,4,6 (dependent on the setting of "no. of motor poles")

III.4.4 Position output

The position output (connector SubD9-X5) produces according to the adjustment of the parameters below a ROD compatible or a synchronous serial position signal.

ROD/SSI [-]

Selects the type of interface, or switches it off when the position output is not used.

Input : OFF, ROD, SSI

NI offset [increment]

Only available if the interface is set to ROD. Determines the position of the zero pulse within a turn at A=B=1. The input is referred to the zero crossing of the resolver and selected resolution.

Input : 0...selected resolution

ROD code [-]

Only available if the interface is set to ROD. Determines whether the output is binary or decimal.

Input : binary or decimal

Resolution [incr./turn]

Only available if the interface is set to ROD. Determines the no. of increments per turn which will be output.

Input : binary 512 / 1024
decimal 500 / 1000

SSI code [-]

Only available if the interface is set to SSI. Selects binary or Gray-code format as output.

Input : binary or Gray

SSI clock [kHz]

Only available if the interface is set to SSI. Selects the SSI-clock rate and the quiescent level of the clock line.

Input : 200, 1500, 200 inv, 1500 inv

III.4.5 I/O

This input determines the function of the I/O-terminal (X3/15).



Please contact us before using the functions Ipeak x%, Set/8 or Mains_BT.

The port is programmed as an input or output, depending on which function you select.

Input functions :

A high signal (24V/7mA, high level = 12 ... 30 V) on terminal X3/15

- RESET** : results in a software-reset (warm boot) of the servo amplifier.
All functions and displays are set to their initial state.
Parameters which not stored in the EEPROM are erased, and the parameter set which is stored in the EEPROM is loaded.
- 1:1CONTR** : produces a 1:1 connection of the speed controller and a switch-off of the actual speed feedback, i.e. it changes over from speed control to current control.
- INTG.OFF** : results in a switch-off of the integral component of the speed controller.
The gain remains at the set value and the actual speed feedback is retained.
- Ipeak x%** : decreases the peak equipment current to x (0...100) %.
After selecting the function and pressing the return-key you can enter the parameter "x".
- Set/8** : decreases the speed to 1/8 of the limit speed.
(not effective with amplifiers with CONNECT Interface).
- Reference** : evaluates the connected reference switch (only effective with amplifiers with CAN CONNECT, PROFIBUS CONNECT oder digilink).

Output functions :

- I²t** : When the I²t signal threshold is reached, a high signal (24 V / 10 mA) is output at terminal X3/15 (open collector).
- BALLAST** : An overload of the set ballast capacity is signalled by a high signal (24 V / 10 mA) at terminal X3/15 (open collector).
- Mains_BT** : monitors the ready-to-operate signal of the digifas™ power stage at terminal X3/15 (open collector) with an high signal (24V/10mA).
- digifas™ 7100**
After switching on the mains voltage the output shows 0V while the intermediate circuit is being loaded.
When the intermediate circuit is loaded, 24V is output.
If the intermediate voltage drops under 100V, 0V is output.
The fault "undervoltage" will not be evaluated.
- digifas™ 7200**
After switching on the mains voltage the output shows 0V while the intermediate voltage is below 100V.
When the intermediate voltage is higher than 100V, 24V is output.
If the intermediate voltage drops under 100V, 0V is output.
The fault "undervoltage" will not be evaluated.

III.4.6 Ballast resistor (only for digifas™ 7103...7116)

Selects the ballast resistor which is used.

Input : internal / external

III.4.7 Ballast power

Limits the continuous power of the ballast resistor.

Input :

digifas™ 7103...7116	200 W with the internal ballast resistor
digifas™ 7103...7116	200...2000 W with an external ballast resistor
digifas™ 7133/7150	200...4000 W, external ballast resistor only
digifas™ 7201...7204	1...75 W, internal ballast resistor only
digifas™ 7206	free convection : 1...75 W, intern. ballast resistor only forced convection : 76...140 W, intern. ballast resistor only

Effects :

Value too low	—	the amplifier will produce an “Overvoltage” signal at an early stage in braking
Value too high	—	ballast resistor can be overloaded.



Fire hazard !

If the ballast power is set to be higher than the permissible continuous dissipation of the externally connected ballast resistor, then the resistor will be thermally overloaded and may burn out.

III.4.8 Control of motor holding brake

If a 24 V holding brake in the motor is to be driven directly from the servo amplifier and the brake option is built into the amplifier, then this parameter can be used to enable the brake function.

Input : with / without

without

Function “brake” disabled

with

If the brake function is enabled (WITH), then 24 V (brake off) will be output at the BRAKE terminal (X1/3) when the enable signal is present and 0 V (brake on) if the enable signal is absent.

Because of their design, the holding brakes of the motors require a time of up to 30 ms, depending on their capacity, to develop the full braking torque.

The braking operation is therefore controlled as follows:

amplifier disabled: the brake is applied at once, the amplifier remains active for 50 ms (100 ms for digifas™ 7100) with set value = 0, until it is certain that the brake has developed the full torque

amplifier enabled: the brake is removed at once, the amplifier is immediately enabled

The diagram on the next page indicates the sequential and functional relationship between the ENABLE signal, speed setpoint, speed and braking force.

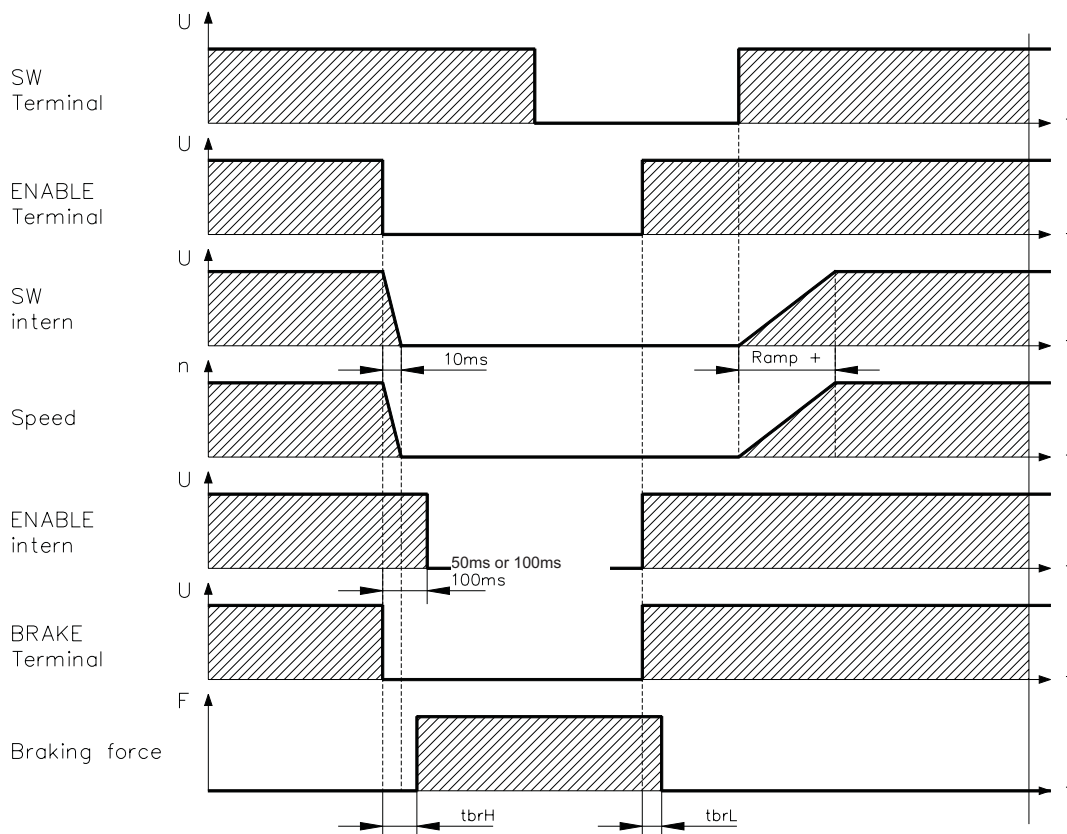

During the internal ENABLE delay time of 50ms (digifas™ 7200) or 100ms (digifas™ 7100) the speed setpoint of the servo amplifier is run down internally to 0 V on a 10 ms ramp.

The activation and release times of the holding brakes which are built into the individual motor types of the 6SM series are different (see the manual for the 6SM motor series).

Mains_BT

Function "BRAKE" disabled. Monitoring of mains voltage active.



Connect the output BRAKE (terminal X1/3) with a pull-down resistor (1kΩ) to CNC-GND if you want to use the function Mains_BT. Please contact us before using the function Mains_BT.

digifas™ 7100 After switching on the mains voltage the output X3/15 shows 0V while the intermediate circuit is being loaded.
 When the intermediate circuit is loaded, 24V is output.
 If the intermediate voltage drops under 100V, 0V is output.
 The fault "undervoltage" will not be evaluated.

digifas™ 7200 After switching on the mains voltage the output X3/15 shows 0V while the intermediate voltage is below 100V.
 When the intermediate voltage is higher than 100V, 24V is output.
 If the intermediate voltage drops under 100V, 0V is output.
 The fault "undervoltage" will not be evaluated.

III.5 Menu page "Service"

On leaving the program, and after switching the parameter "Offline Editing" to ON, all the service functions which are active are inhibited.

III.5.1 Parameter update (F2)

The current set of parameters is read out from the memory of the servo amplifier and displayed on the screen. This function is useful for amplifiers with a fieldbus interface, which can be parametrized via the bus. The screen display can be refreshed by using **F2**.

III.5.2 Constant direct current (F5, F9)

The drive is run with adjustable constant-current and electrical angle. The changeover from speed to current control is made automatically. This type of setpoint provision only takes effect after the key **F5** has been operated and the confirmation query has been answered with "Y". The analog setpoint input is out of function. The function is terminated by the function key **F9**.

Input : setpoint : 0 ... +I_{nom}, resolution 0.1 A
 elect. angle: 0...359° electr., resolution 1°electr. (the value is adapted,
 because of the internal data format)

III.5.3 Const. speed (F6, F9)

This produces an internal digital fixed-setpoint input, which can be reversed in amplitude and polarity for test purposes. The setpoint does not become active until the function key **F6** is pressed and the query is confirmed by answering "Y". The analog input is disabled as long as the function is active. The function is terminated by the function key **F9**.

Input limits: -speed limit ... +speed limit, resolution 0.1 rpm

III.5.4 Const. current (F7, F9)

Operates the drive with constant current. The changeover from n- to I-control is made automatically. The setpoint does not become active until the function key **F7** is pressed and the query is confirmed by answering "Y". The analog input is disabled as long as the function is active. The function is terminated by the function key **F9**.

Input limits: -I_{nom} ... +I_{nom}, resolution 0.1 A

III.5.5 Reverse mode (F8, F9)

For operating the drive in reverse mode for test purposes, with an adjustable setpoint and reversing time. The setpoint does not become active until the function key **F8** is pressed and the query is confirmed by answering "Y". The analog input is disabled as long as the function is active. The function is terminated by the function key **F9**.

Input : setpoint : 1...100% of the set speed limit in rpm, resolution 1 %
 (the value is adapted, because of the internal data format)
 time : 50...12000 ms, resolution 50m

III.6 Menu page "Actual values"

Internal temperature

The internal temperature is displayed in °C.

Heat sink temperature

The temperature of the heat sink is displayed in °C.

Intermediate circuit voltage

The DC-intermediate circuit voltage is displayed in V.

I²t

The actual effective (rms) load is displayed in % of the set effective current I_{rms} .

Ballast power

The actual power dissipation in the ballast is displayed in W.

Speed

The actual speed of the motor is displayed in rpm.

Actual current value

The actual effective output current (active current) is displayed in A.

Angle of rotation

The indication is the current angular position of the rotor (only for $n < 20 \text{ min}^{-1}$) in °mech, and counts, referred to the mechanical zero point of the measurement system. In this case there is a dependency on the no. of poles of the resolver which is used.

No. of resolver poles	No. of zero marks	No. of circular segments	Display
2	1	1	0...360°
4	2	2	2 x 0...180°
6	3	3	3 x 0...120°

Operating time

The operating hours counter of the servo amplifier.

Fault statistics

This displays the number of faults which have occurred, and, for the last three faults, the elapsed time relevant to the operating time counter.

After operating the return key in the entry field for "Fault statistics", a screen page appears with a display of the frequency of all faults which caused the servo amplifier to switch off.

You can leave this page by pressing the ESC key.

III.7 Menu page "Connect"

The CONNECT menu page can only be called up when the attached servo amplifier is equipped with an interface module:

BIT CONNECT / PULSE CONNECT / PROFIBUS CONNECT / CAN CONNECT / digilink

The CONNECT menu page is disabled if the servo amplifier does not have an interface; it also does not appear in the selection line. You will find a description of the parameters and the menu page in the technical description for the particular interface module.

IV Drive optimization

In the digifas™ servo amplifiers current and speed are controlled digitally by the internal amplifier software. In instruments with CONNECT modules the position controller is available as an additional control loop.

The control parameters for the individual control loops are set up with the operator software BS7200. The parameters can be found on the following menu pages (see also Chapter III) :

Control loop	Menu page	Comment
Current controller	CURRENT	see Chapter III.2
Speed controller	SPEED	see Chapter III.3
Position controller	CONNECT	only if a CONNECT module is installed, the parameters are described in the corresponding CONNECT manual

All parameters define the **real** time constants, factors, currents etc. This makes it easier to understand their interrelations and the effects which can be achieved.

Preparation

Oscilloscope : connect an oscilloscope between connector X3 (IDC/VTA) and AGND.

Reversing mode : in the SERVICE menu pages, set the parameters for reversing mode to values which are not dangerous even when the position control loop is switched off (approx. 10 % of the final speed).

Analog setpoint : for instruments without a CONNECT module, provide a setpoint of 0 V at terminal X3/1-2.



For the service function “Reversing mode” the analog setpoint input is switched off or the internal position control is disabled.

Take care that independent movement of the selected axis is possible without causing any danger. To be safe, operate the ENABLE signal of the amplifier by a confirmation key and ensure the EMERGENCY STOP function for this axis.

The control loops function together as a classic cascade control. During optimization you must proceed in the functional sequence of the control loops :

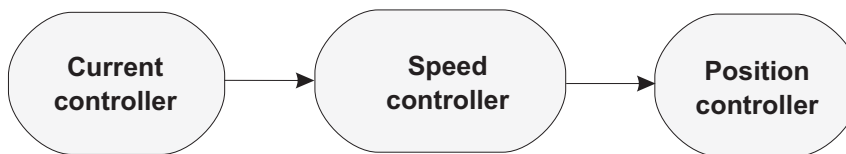

Optimizing the current controller (menu page: CURRENT):

Load default values

Disable the amplifier. Load the motor-specific default values (menu page “Handling” : “Load default values”).

If the motor/amplifier combination is a good match, then the current controller will already be stable for nearly all applications. Parameters which are not described below will usually not have to be altered.

I_{peak}

Reduce I_{peak} to the I_{nom} of the motor, as far as the machine permits. Now enable the amplifier.

If the current controller is not stable in operation (the setpoint speed is not reached or the motor oscillates with a frequency clearly above 100 Hz) or the motor which is used is not recorded in the data bank of default values, please contact our applications department.

Optimizing the speed controller (menu page: SPEED):

- SW-OFFSET
- Leave the amplifier enabled. If the axis drifts, alter the parameter SW-Offset until it stays still.
- FINAL SPEED
- Set the intended final speed.
If the parameter "Final speed" is altered, the influence of K_p is affected in inverse proportion.
- DC-MONITOR
- Set the DC-Monitor to CURRENT.
- K_p/T_n
- Increase K_p until the motor starts to oscillate (audible, and visible on the oscilloscope), and then reduce K_p again until the oscillation has **clearly** stopped and stability is assured.
Use the motor motor-specific value for T_n.
- DC-MONITOR
- Set the DC-Monitor to TACHO.
- Start reversing mode
- Start the reversing mode (F8). Study the waveform of the tachometer voltage on the oscilloscope. If the setting is correct, a **stable step response** can be observed in both directions.

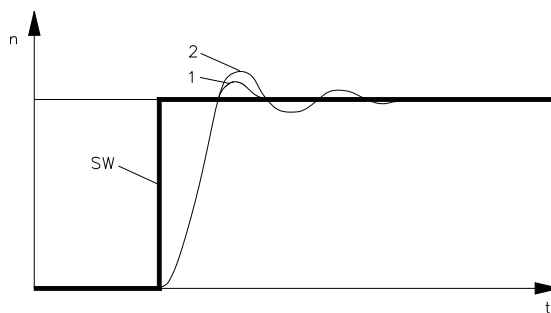

Fig : step response
n = speed
n_{soll} = speed setpoint
SW = setpoint
t = time
1 = optimum
2 = K_p to high (adjust PID-T2)

- K_p
- By carefully increasing K_p you can make a fine optimization of the speed response. Aim: minimum overshoot but still good damping.
- PID-T2
- Disturbances, such as slight gearbox play, can be damped out by increasing PID-T2 to about 1/3 of the value of T_n.
- T-TACHO
- Especially for small drives with low torque: you can improve smooth running with T-Tacho.
- Finish reversing mode
- Finish the reversing mode (F9).
The position control loop is now closed again.
Set the correct motor-specific value for I_{peak} again.
- SW-RAMP +/-
- The setpoint ramps are used to smooth out the setpoint entry (filter effect). Set the mechanical time constant of the complete system, i.e the rise time of the speed from 0 to n_{setp}.
As long as the ramps which are set are shorter than the mechanical response time of the complete system, the response speed will not be affected. Operate program-controlled motion blocks, and set up the ramp times to suit.

If the drive does not run satisfactorily under position control, look first for other causes such as :

- mechanical play in the transmission
- jamming or stick-slip effects
- self-resonant frequency of the mechanical system is too low
- poor damping, drive is too weakly dimensioned

before repeating the optimization of the control loops.

V Appendix

V.1 Delivery package, storage, disposal

Delivery package : — 3.5"-diskette with the operator software BS7200, as part of the delivery package for a servo amplifier of the digifas™ series

— BS7200 operating manual

Storage :

— dust, moisture, magnetic or electrical fields, extreme temperatures and incorrect mechanical handling of the diskette can destroy the data stored on the diskette

— only in the original (recyclable) manufacturer's packaging

— storage temperature +10...+60 °C, max. 20 °C/hour variation

— humidity relative humidity: max. 95% , no condensation

— storage time no limit

Disposal :

— Disposal should only be carried out by certified disposal companies. We can give you suitable addresses.

V.2 Fault-finding

Fault	possible cause	method of removing the cause of the fault
Error message Communication fault	<ul style="list-style-type: none"> — wrong PC-cable used — PC-cable plugged in to wrong connector in servo amp. or PC — wrong PC-port/interface selected — PC driver power insufficient — booster / booster supply defect — mains supply for booster is not functioning properly — PC is not earthed 	<ul style="list-style-type: none"> — use a Seidel PC-cable — plug in PC-cable to correct connector in servo amp/PC — correct operator software call — use booster — replace booster / booster supply — check mains supply — earth PC
Drive reports contouring error	<ul style="list-style-type: none"> — I_{rms} or I_{peak} is set too low — setpoint ramp is too steep 	<ul style="list-style-type: none"> — increase I_{rms} or I_{peak} (check motor data !) — reduce SW-ramp +/-
Motor is hot	<ul style="list-style-type: none"> — I_{rms}/I_{peak} is set too high 	<ul style="list-style-type: none"> — reduce I_{rms}/I_{peak}
Drive too soft	<ul style="list-style-type: none"> — K_p (speed controller) is too small — T_n (speed controller) is too large — PID-T2 is too large — T-Tacho is too large 	<ul style="list-style-type: none"> — increase K_p (speed controller) — use motor specific value for T_n — reduce PID-T2 — reduce T-Tacho
Drive runs roughly	<ul style="list-style-type: none"> — K_p (speed controller) is too large — T_n (speed controller) is too small — PID-T2 is too small — T-Tacho is too small 	<ul style="list-style-type: none"> — reduce K_p (speed controller) — use motor specific value for T_n — increase PID-T2 — increase T-Tacho
Axis drifts when setpoint = 0V	<ul style="list-style-type: none"> — offset incorrectly adjusted for analog setpoint provision 	<ul style="list-style-type: none"> — adjust SW-offset (speed controller)

V.3 Glossary

B	Ballast circuit	converts excess regenerative energy from the motor during braking into heat in the ballast resistor
C	Clock	clock signal
	Common-mode voltage	amplitude of the disturbance which can be eliminated in an analog input (differential input)
	CONNECT module	module built into the servo amplifier, with integral positional control, which provides special interface variations for the connection to the higher-level control
	Counts	internal count pulses, 1 pulse = 1/4096 of 1 turn
	Continuous ballast power	average power which can be dissipated by the ballast circuit
	Current controller	regulates the difference between the current setpoint and the actual current value to 0. output : power output voltage
D	Disable	removal of the ENABLE signal (0V or open)
E	Earth short	electrically conductive connection between a phase and PE
	Enable	enable signal for the servo amplifier (+24V)
F	Field-bus interface	here: CONNECT module CAN-CONNECT and PROFIBUS-CONNECT
	Final limit speed	max. value of normalized speed at $\pm 10V$
G	GRAY code	special form of binary encoding
H	Holding brake	a brake in the motor which must only be activated at standstill
I	Input drift	temperature and age-dependent changes in an analog input
	I ² t threshold	monitoring of the actual effective current demand I _{rms}
	Incremental encoder interface	position signal by 2 signal with 90° phase difference, not an absolute position signal
	I _{peak} , peak current	effective value of the pulse current
	I _{rms} , effective current	effective value of the continuous current
	Intermediate circuit	rectified and smoothed power DC voltage
K	K _p , P-gain	proportional gain of a control loop
L	LC display	liquid-crystal display
	Limit switch	limit switch for the traverse path of the machine; implemented as break contact
M	Machine	the sum of all components which are connected together and of which at least one is movable
	Mains filter	external device to divert disturbances on the power leads to PE
	Monitor output	output of an analog measurement value
	Motion block	data packet with all the positional control parameters which are required to perform a movement – only when a CONNECT module is available
	Multi-axis system	machine with several independent drive axes

N	Natural convection	free air movement for cooling
	NI pulse	is produced once per turn by incremental encoders, used to establish the zero point for the machine
O	Optocoupler	optical connection between two electrically independent systems
P	P-controller	control loop with purely proportional characteristic
	Phase shift	compensation for the phase lag between the electro-magnetic and magnetic fields in the motor
	PID-Regler	a control loop with proportional, integral and differential characteristics
	PID-T2	filter time constant for the speed control
	Position controller	regulates the difference between the position setpoint and the actual positional value to 0. output : speed setpoint
	Potential isolation	electrically decoupled
R	Power contactor	system protection with phase-failure monitoring
	Pulse power of the ballast circuit	maximum power which can be dissipated in the ballast circuit
	Reset	new start of the microprocessor
	Resolver-digital converter	conversion of the analog resolver signals into digital information
S	Reversing mode	operation with a periodic change of direction
	Ring core	ferrite ring(s) for interference suppression
	Servo amplifier	device for the control of speed and torque of a servo motor
	Short-circuit	here: electrically conductive connection between two phases
	Speed controller	regulates the difference between the speed setpoint SW and the actual speed to 0. output: current setpoint
T	SSI-interface	cyclically absolute, serial positional information
	SW ramp	limitation of the rate of change of the speed setpoint SW
	T-tacho, tachometer time constant	filter time constant in the speed feedback of the control loop
	Tachometer voltage	a voltage which is proportional to the speed
Z	Thermal cut-out contact	a temperature sensitive switch which is built into the motor winding
	Tn, I-time constant	integral component of the control loop
	Zero pulse	is produced once per turn by incremental encoders, used to establish the zero point for the machine

V.4 Operating parameter list

Group	Display text	Remarks	Units	Min	Max	Default digifas™ 7100	Default digifas™ 7200
Current controller	I_{rms}	effective current	A	0.1	I_{nom}	0.5I_{nom}	0.5I_{nom}
	I_{peak}	peak current	A	$0.2 \times I_{nom}$	$2 \times I_{nom}$	I_{nom}	I_{nom}
	I^2t threshold	monitoring threshold	%	0	100	80	80
	Kp	proportional gain	-	0.1	8	1.5	1.5
	Tn	integr. time constant	ms	0.1	10	0.6	0.6
Speed controller	Kp	proportional gain	-	0.1	63	10	10 (5)**
	Tn	integr. time constant	ms	0.1	1000	10(12)*	10 (5)**
	PID-T2	2. time constant	ms	0.2	25	2,0	2,0 (0.6)**
	SW offset	compensation	mV	-120	+120	0	0
	SW ramp +	ramp up	ms	2	6300	10	10
	SW ramp -	ramp down	ms	2	6300	10	10
	final limit speed	final tacho speed	min ⁻¹	800	8000	3000	3000
	DC monitor	Function X1/3 (IDC/VTA)	-	TACHO/ CURRENT	S_fehl/ I-soll	TACHO	TACHO
	Limit switch	on/off/stop	-	off/on	stop	off	off
	Start Phi	Phasen lead	min ⁻¹	0	0,8x final speed	1500	1500
	Limit Phi	Phasen lead	°electr.	0	45	20	20
	T-Tacho	tacho time constant	ms	0.2	100	0.6	0.6 (0.2)**
	Speed steadiness	speed steadiness	-	off	on	off	off
General	Motor pole no.	steps ±2	-	2	12	6	6
	Language	operating language	-	German	Engl./French	German	German
	Res. pole no.	steps 2/4/6	-	2	6	2	2
	I/O	programmable input/output	-	various	various	RESET	RESET
	Ballast resistor	select ballast resistor	-	internal	external	int.(ext.)*	-
	Ballast power	ballast power	W	various	various	200 (860)*	75
	Brake	unction output BRAKE	-	without/ with	Maisn_BTBT	without	without
	ROD/SSI	position output	-	ROD/SSI	off	ROD	ROD
	NI offset	ROD zero-pulse pos.	Incr.	0	resolution	0	0
	ROD code	ROD output format	-	binary	decimal	bin	bin
	Resolution	ROD resolution	Incr/turn	512/1024	500/1000	1024	1024
	SSI code	SSI output format	-	binary	Gray	bin	bin
	SSI clock	SSI clock rate	kHz	200/200	1500/1500	200	200

* values in brackets only for digifas™ 7133...7150

** values in brackets only for digifas™ 7201

Customer _____ Cabinet no. _____ Unit no. _____

Place, date _____ Signature _____

V.5 Index

- | | | | | | |
|----------|---|--------|----------|--|--------|
| I | 1:1 control | III-14 | M | Mains_BT B (BRAKE) | III-16 |
| | 2.time constant (PID-T2) | III-10 | | Mains_BT B (I/O) | III-14 |
| A | actual angle of rotation | III-18 | | message ballast. | III-14 |
| | actual ballast dissipation | III-18 | | message I ² t | III-14 |
| | actual current | III-18 | N | NI-offset | III-13 |
| | actual heat sink temperatur | III-18 | | no. of motor poles | III-13 |
| | actual I ² t load | III-18 | | no. of resolver poles | III-13 |
| | actual intermediate circuit voltage | III-18 | | NSTOP | III-12 |
| | actual internal temperatur | III-18 | O | Offset | III-10 |
| | actual operating time | III-18 | | operating time | III-18 |
| | actual speed | III-18 | | operation | II-4 |
| | actual-value display | II-6 | | other operating systems | II-2 |
| B | ballast power | III-15 | P | parameter list | V-4 |
| | ballast resistor. | III-15 | | Parameter update. | III-17 |
| | boot disk | II-2 | | path | III-2 |
| | brake | III-15 | | PC cable parallel | I-4 |
| C | command mode. | II-4 | | PC cable serial | I-4 |
| | constant current. | III-17 | | peak current (I _{peak}). | III-9 |
| | Constant speed | III-17 | | P-gain (K _p , current). | III-9 |
| | Constanter direct current | III-17 | | P-gain (K _p , speed) | III-10 |
| | create directory | III-2 | | phase shift | III-12 |
| | current controller | III-9 | | position output | III-13 |
| D | DC monitor | III-11 | | print parameters. | III-8 |
| | Delivery package | V-1 | | PSTOP | III-12 |
| | directory. | III-2 | R | ramp - | III-11 |
| | disposal | V-1 | | ramp+ | III-10 |
| | Drive optimization | IV-1 | | Reference | III-14 |
| E | edit offline | III-1 | | reset function | III-14 |
| | effective current (I _{rms}) | III-9 | | resolution | III-13 |
| | error messages | II-6 | | reverse mode | III-17 |
| F | Fault statistics. | III-18 | | ROD/SSI | III-13 |
| | Fault-finding. | V-1 | S | S_fault. | III-11 |
| | function keys | II-5 | | Safety instructions | 1-C |
| G | Glossary. | V-2 | | save to disk | III-3 |
| H | Hardware requirements | I-3 | | Save to EEPROM. | III-1 |
| | humidity | V-1 | | Screen layout | II-3 |
| I | I/O terminal | III-14 | | select directory | III-2 |
| | I ² t message | III-9 | | Set/8 | III-14 |
| | input mode | II-4 | | speed controller. | III-10 |
| | Installation DOS. | II-1 | | speed limit. | III-11 |
| | integration time (T _n , current) | III-9 | | speed steadiness | III-12 |
| | integration time (T _n , speed). | III-10 | | speed value filter (T-Tacho). | III-12 |
| | INTG.OFF | III-14 | | SSI clock | III-13 |
| | I _{peak} x% | III-14 | | SSI code | III-13 |
| | I-set | III-11 | | start phi | III-12 |
| L | language | III-13 | | status line | II-5 |
| | limit phi | III-12 | | status messages | II-6 |
| | limit switch | III-12 | | STOP (OFF) | II-5 |
| | load default settings. | III-6 | | storage | V-1 |
| | load from disk | III-4 | | storage temperature | V-1 |
| | | | | storage time. | V-1 |
| | | | U | Use as directed | I-1 |

Vertrieb und Service / Sales and Service / Agence et Services

<u>Bundesrepublik Deutschland / Germany / Allemagne</u> Kollmorgen Seidel GmbH & Co. KG Verkaufsniederlassung Nord Wacholderstr. 40-42 40489 Düsseldorf Tel.: +49(0)203 - 99 79 214 Fax: +49(0)203 - 99 79 182	<u>Dänemark / Denmark / Danemark</u> DIGIMATIC A/S "Laerkefeldt" Aalkaergaardvej 20 8700 Horsens Nord Tel.: +45 - 75 65 66 66 Fax: +45 - 75 65 68 33	<u>Italien / Italy / Italie</u> M.C.A. s.r.l. Via f. Turati 21 20016 Pero (Mi) Tel.: +39(0)02 - 33 91 04 50 Fax: +39(0)02 - 33 90 85 8
Kollmorgen Seidel GmbH & Co. KG Verkaufsniederlassung West Lilienstraße 3 42719 Solingen Tel.: +49(0)212 - 2 30 77 99 Fax: +49(0)212 - 2 30 77 97	<u>Finnland / Finland / Finlande</u> Drivematic OY Hevosenkentä 4 28430 Pori Tel.: +358 - 2 - 61 00 33 11 Fax: +358 - 2 - 61 00 33 50	<u>Niederlande / Netherlands / Pays-Bas</u> Dynamic Drives Wattstraat 26f 2723 RC Zoetermeer Tel.: +31(0)79 - 59 39 214 Fax: +31(0)79 - 59 39 840
Kollmorgen Seidel GmbH & Co. KG Verkaufsniederlassung Mitte Bussardweg 38 61118 Bad Vilbel Tel.: +49(0)6101 - 55 866 00 Fax: +49(0)6101 - 55 866 06	<u>Frankreich / France / France</u> Kollmorgen Seidel GmbH & Co. KG Parc technologique St.Jacques 2 rue Pierre et Marie Curie 54320 Maxéville Tel.: +33(0)3 83 95 44 80 Fax: +33(0)3 83 95 44 81	<u>Schweden / Sweden / Suède</u> S D T AB 25467 Helsingborg Tel.: +46(0)42 - 380 800 Fax: +46(0)42 - 380 813 Stockholm 12030 Stockholm Tel.: +46(0)8 - 640 77 30 Fax: +46(0)8 - 641 09 15 Göteborg 42671 Västra Frölunda Tel.: +46(0)31 - 69 62 60 Fax: +46(0)31 - 69 62 69
Kollmorgen Seidel GmbH & Co. KG Verkaufsniederlassung Süd-West Lessingstr. 41 75015 Bretten Tel.: +49(0)7252 - 97 39 040 Fax: +49(0)7252 - 97 39 055	Kollmorgen Seidel GmbH & Co. KG 216 Lotissement Les Peiffendes Le Sonnant d'Uriage 38410 Uriage Tel.: +33(0)4 76 59 22 30 Fax: +33(0)4 76 59 22 31	<u>Schweiz / Switzerland / Suisse</u> Kollmorgen Seidel GmbH & Co. KG Bühnrain 30 8052 Zürich Tel.: +41(0)1 - 300 29 65 Fax: +41(0)1 - 300 29 66
Kollmorgen Seidel GmbH & Co. KG Verkaufsniederlassung Süd-Ost Landsbergerstr. 17 86947 Weil Tel.: +49(0)8195 - 99 92-50 Fax: +49(0)8195 - 99 92-33	<u>Großbritannien / Great Britain / Royaume-Uni</u> Kollmorgen PO Box 147, KEIGHLEY West Yorkshire, BD21 3XE Tel.: +44(0)15 35 - 60 76 88 Fax: +44(0)15 35 - 68 05 20	<u>Spanien / Spain / Espagne</u> BROTOMATIC S.L. C/San Miguel de Acha, 2 Pab.3 01010 Vitoria (ALAVA) Tel.: +34 945 - 24 94 11 Fax: +34 945 - 22 78 32
Servo-Dyn Technik GmbH Münzgasse 10 01067 Dresden Tel.: +49(0)351 - 49 05 793 Fax: +49(0)351 - 49 05 794	Heason Technologies Group Claremont Lodge Fontwell Avenue Eastergate Chichester PO20 6RY Tel.: +44(0)12 43 - 54 54 00 Fax: +44(0)12 43 - 54 45 90	

Systempartner / System partners / Partenaires du système

<u>Bundesrepublik Deutschland / Germany / Allemagne</u> Werner P. Hermes Ingenieurbüro Turmstr. 23 40750 Langenfeld Tel.: +49(0)212 - 65 10 55 Fax: +49(0)212 - 65 10 57	<u>Großbritannien / Great Britain / Royaume-Uni</u> Motor Technology Ltd. Unit 1 Chadkirk Industrial Estate Otterspool Road Romiley, Stockport Cheshire SK6 3LE Tel.: +44(0)161 - 42 73 641 Fax: +44(0)161 - 42 71 306	<u>Italien / Italy / Italie</u> Servo Tecnica Viale Lombardia 20 20095 Cusano Milanino (MI) Tel.: +39 (0)02 - 66 42 01 Fax: +39 (0)02 - 66 40 10 20
EAT GmbH Elektronische Antriebstechnik Hanferstraße 23 79108 Freiburg Tel.: +49(0)761 - 13 03 50 Fax: +49(0)761 - 13 03 555	<u>Niederlande / Netherlands / Pays-Bas</u> Kiwiet Ingenieurbüro Helenaveenseweg 35 5985 NK Panningen (Grashoek) Tel.: +31(0)77 - 30 76 661 Fax: +31(0)77 - 30 76 646	<u>Türkei / Turkey / Turquie</u> Robotek Otomasyon Teknolojileri Ali Nihat Tarlan CAD. Kartal Sk. No: 16/7 Üstbostancı YSTANBUL Tel: +90 216 464 50 64 pbx Fax: +90 216 464 50 72
IBK Ingenieurbüro Keßler GmbH Dachtmisser Str. 10 21394 Kirchgellersen Tel.: +49(0)4135 - 12 88 Fax: +49(0)4135 - 14 33	<u>Schweiz / Switzerland / Suisse</u> Bobby Servo Electronic AG Zentralstr. 6 6030 Ebikon Tel.: +41(0)41- 440 - 77 22 Fax: +41(0)41- 440 - 69 43	<u>Griechenland / Greece / Grèce</u> Alpha Motion 5 - 7 Alkamenoy's Str. 104.39 Athens Tel.: +30 1 82 27 470 Fax: +30 1 82 53 787
MACCON GmbH Kühlbachstr. 9 81543 München Tel.: +49(0)89 - 65 12 20-0 Fax: +49(0)89 - 65 52 17	<u>Ungarn / Hungary / Hongrie</u> Q-TECH Mernöki Szolgáltató Kft. 1161 Budapest Batthyány u. 8. Tel.: +36 (1) 405 - 33 38 Fax: +36 (1) 405 - 91 34	<u>Australien / Australia / Australie</u> Motion Technologies PTY. Ltd. 1/65 Alexander Avenue Taren Point NSW 2229 Sydney Tel.: +61 (0)295 24 47 82 Fax: +61 (0)295 25 38 78

Kollmorgen Seidel GmbH & Co. KG

Hausanschrift

Wacholderstr. 40-42
D - 40489 Düsseldorf
Tel.: +49(0)203 - 99 79 - 0
Fax: +49(0)203 - 99 79 - 155
Internet : <http://www.kollmorgen-seidel.de>

Postanschrift

Postfach 34 01 61
D-40440 Düsseldorf

Kollmorgen

Motion Technologies Group

201 Rock Road
Radford, VA 24141, USA
Tel.: +1 540 - 639 - 24 95
Fax: +1 540 - 731 - 08 47
Internet : <http://www.kollmorgen.com>